



CONDAIR DL

Hybrid spray and
evaporative humidifier



Close control adiabatic humidifier with ultra hygienic performance

Reverse osmosis water treatment

The supply water is purified to less than $15\mu\text{S}$ to prevent minerals from being introduced to the duct and to maintain hygienic operation.

Water softener

Softened water is required to achieve the required water purity and prolongs the operational lifetime of the RO filters.



Pump and silver ionisation unit

Condair's patented Hygiene Plus system treats the water with silver ionisation to actively inhibit microbial growth throughout the humidifier.

Control panel

Incorporating the latest touch screen technology, the control panel provides intuitive operation and advanced reporting.

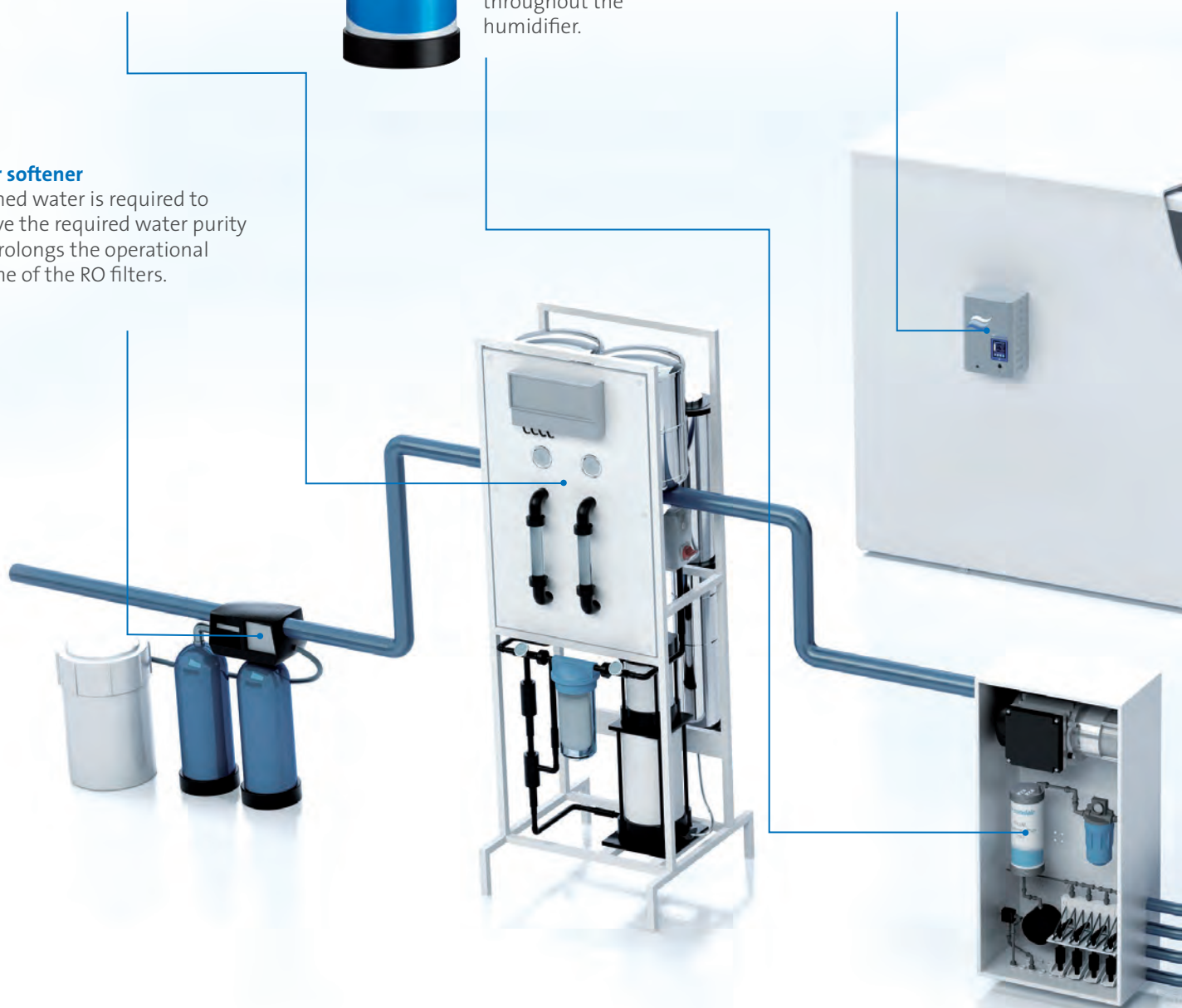

CONDAIR DL

Hybrid spray and evaporative humidifier



Atomising nozzle grid

Spray nozzles initially activate in stages and then operate with fully modulating output to provide very accurate humidity control.



Ceramic evaporative unit

Has the dual effect of removing droplets from the airstream and allowing evaporation from its porous surface, improving humidification efficiency and minimising drain water.

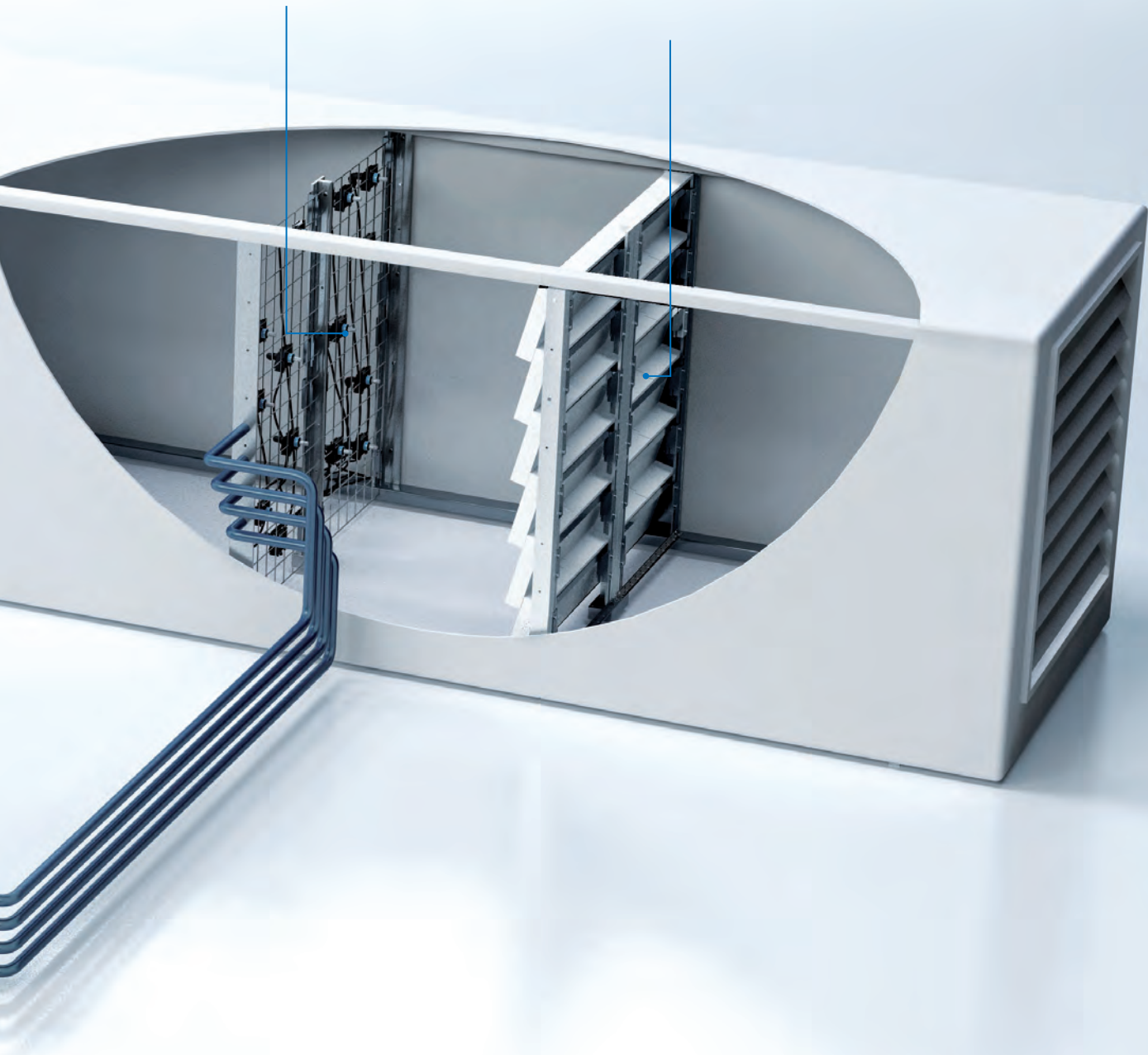

By combining spray and evaporative technologies, the Condair DL provides a level of humidity control typically only achievable from electric steam humidifiers but with the low energy consumption of an adiabatic system.

A $\pm 2\%RH$ control accuracy can be delivered through the use of multi-stage and fully modulating spray output followed by moisture evaporation from the ceramic evaporative module.

The Condair DL has many anti-microbial features, making it one of the most hygienic adiabatic humidifiers in the world.

The system has been independently tested and achieved SGS Institut Frensenius certification for hygienic operation.



Variable pressure sprays allow a fully modulating output for extremely close humidity control

Close control adiabatic humidifier

The Condair DL offers close humidity control of up to $\pm 2\%RH$ by combining variable pressure spray and evaporative technology.

The humidifier's output is increased initially in stages by incrementally activating sets of nozzles on the grid. Depending on the size of unit, this can be from 7 to 31 initial stages of control. Following this initial output, the humidifier's pump will increase the water pressure up to 7 bar across the complete nozzle grid, providing fully modulating control up to full output.

This level of control is not possible with either in-duct high pressure spray or evaporative humidifiers and is similar to the accuracy of steam humidification.

Each nozzle can be adjusted to a 15° angle in any direction on the manifold. This reduces wetting on the duct wall, provides a more even mist across the duct, uniform humidification on the evaporative module and a consistent humidity throughout the airstream.

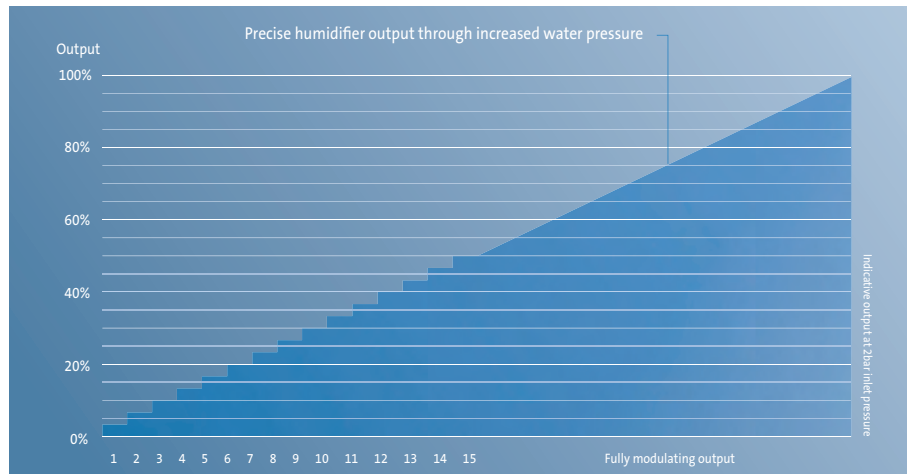

Close control of $\pm 2\%RH$ from initial stage then fully modulating control

The ceramic evaporative module located opposite the nozzle grid removes unabsorbed water droplets from the air and prevents wetting

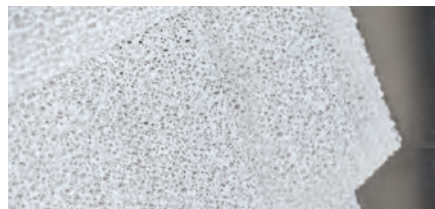

downstream. Moisture not absorbed by the air in the spray section is evaporated from its surface. This results in improved humidification and efficient water use, with very little water going to drain.

Due to its innovative design it causes a lower pressure drop than evaporative humidifiers (40Pa @ 2m/s), reducing the power consumption of AHU fans.



Silver ionisation of the water inhibits microbial growth throughout the humidification system and the in-duct humidifier section

Advanced hygiene features

The Condair DL incorporates many hygiene features to make it one of the most hygienic in-duct adiabatic humidifiers in the world. The system has been independently tested by the SGS Institut Frensenius in Germany and certified for hygienic operation. Throughout a six month testing period the humidifier outperformed the VDI6022 industry standard for microbial growth, achieving a maximum CFU/ml microbial count 85% less than the recommended limit.

A patented Hygiene Plus feature provides silver ionisation water treatment. Silver has a residual sterilising effect and actively inhibits microbial growth throughout the

humidifier. The Hygiene Plus system delivers the exact level of disinfecting silver needed depending on the humidity output at any time.

Alongside the system operating on pure RO water, flush and drain cycles ensure water cannot remain in supply pipelines or the humidifier itself long enough to stagnate. The system will drain if left unused for 12 hours and perform a flush cycle whenever powered-up.

An optional pipe flushing feature allows water to be drained from the pipework between the RO filter and the central pump station.



Patented Hygiene Plus silver ionisation

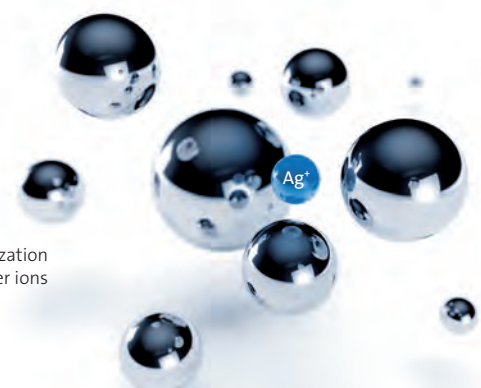

Effective germ neutralization with silver ions



Reducing operating costs and a building's carbon footprint

Low energy humidification and adiabatic cooling

In-duct adiabatic humidifiers can significantly reduce the operating cost of a building's humidity control when compared to traditional electric steam humidifiers.

As moisture is absorbed using heat from the air, rather than by electrically heating water to create steam, the main energy source can be shifted from electricity to gas. By warming the air prior to the humidifier with gas-fired heating, the exact same amount of energy is consumed but as gas is much cheaper, the humidification system's overall operating cost is reduced.

If it is possible to recover waste heat from the building to pre-heat the airstream prior to the humidifier, the energy cost of Condair DL humidification is a tiny fraction in comparison to using electric steam humidifiers.

The Condair DL can also be used in the summertime to provide low energy adiabatic cooling to an air handling unit. For every 1kg of humidity absorbed by the air around 0.68kW of cooling is also delivered. As a single Condair DL can provide up to 1,000kg/h, the system can supply approximately 680kW of adiabatic cooling per hour, while operating on around 1kW of electricity.

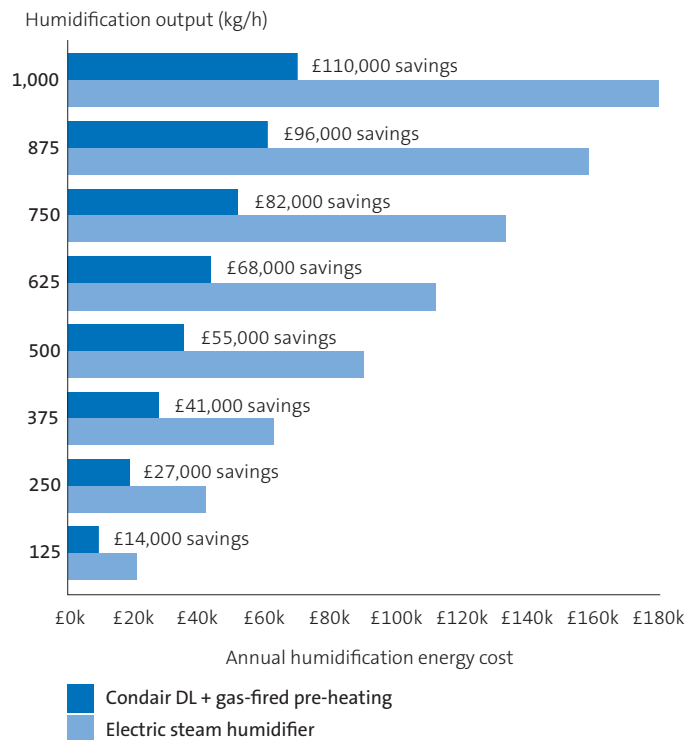

Based on full humidifier output for 2,500 hours per year, gas at 3p/kWh and 80% efficient pre-heating, and electricity at 9p/kWh and a 94% efficient electric steam humidifier.



Touch screen controller for intuitive operational control and advanced reporting

Control at your fingertips

The Condair DL incorporates the latest touch screen control panel, providing intuitive operation and extensive reporting.

Operating parameters can be seen at a glance and easily adjusted, service and fault history is displayed, and detailed trouble-shooting suggestions offered.

A USB connection allows all performance data to be recorded and exported into Excel for advanced diagnostics. Upgrades to software can also easily be made via the USB port.

BMS connectivity is included as standard using Modbus, BACnet IP and BACnet MSTP (slave). An optional PCB for LonWorks and BTL certified BACnet is also available.

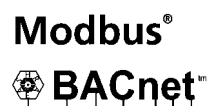

Operational status, fault and maintenance data is recorded via USB and analysed in Excel.

Typical system overview

- 1 Control panel
- 2 Central unit (pump and silver ion water treatment)
- 3 Spray nozzle grid
- 4 Ceramic evaporative unit

Accessories

- a Water supply flushing valve
- b In-duct humidistat

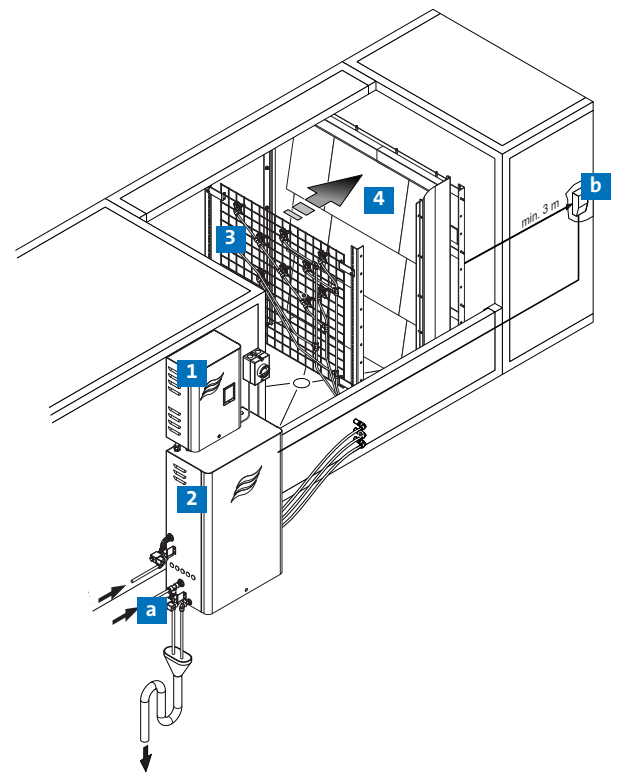

Options

- Water softener
- Reverse osmosis water treatment system
- Leak monitoring
- External pipe flushing set
- BMS gateway board (LonWorks or BACnet IP/BACnet MSTP)
- Mounting frame for pump station and control unit
- Silicon-free
- Droplet eliminator (for air velocities 3-4m/s)

Technical data

Dimensions / Weight	Type A (with booster pump)	Type B (without booster pump)
Absorption distance in AHU/duct (min-max)	600–900mm	
Width AHU/duct (min-max)	450–4,500mm	
Height AHU/duct (min-max)	450–4,000mm	
Central unit HxWxD	800 x 500 x 250mm	
Central unit weight	Approx. 54kg	Approx. 35kg
Control unit HxWxD	450 x 315 x 190mm	
Control unit weight	Approx. 14kg	
Hydraulic		
Humidification capacity	10–1,000kg/h	
Nozzle pressure	3–7 bar	
Nozzle sizes	1.5, 2.5, 3.0, 4.0, 5.0kg/h @ 4bar	
Water quality requirement	Reverse osmosis water 0.5–15.0µS/cm	
Electric		
Supply voltage/current control unit	200-240VAC / 50-60Hz, max 6A	
Control booster pump motor	Continuous with frequency converter	-
Control unit power consumption	55-65VA	
Motor rating booster pump	Approx. 10VA per 10kg/h spray capacity	-
Frequency converter	Yes	No
Control accuracy	7 steps: ±3%RH 15 steps: ±2%RH 31 steps: ±2%RH	7 steps: ±4%RH 15 steps: ±3%RH 31 steps: ±2%RH
Communication		
Remote operating & fault indication board	Yes	
Modbus RTU	Yes	
BACnet IP and BACnet MSTP slave mode	Yes	
Air		
Pressure drop (2m/s)	Approx. 40Pa	
Max. air velocity	3m/s without droplet eliminator. 4m/s with droplet eliminator	
Air filter quality before humidifier	F7 (EU7) or better	
Max. recommended air temp	60°C (before humidifier)	

Larger units available on demand. Higher temperatures available on demand. Control accuracy may vary depending on various external factors, e.g. temperature.